

SUMMARY

This document includes both the installation and user guides of the 4E-GPIO remote input/output module for 4EVAC voice evacuation systems. It explains how the 4E-GPIO should be installed and configured. The installation instructions are addressed to trained technical personnel, such as installers, service technicians and commissioning engineers. The user instructions explain how to operate the 4E-GPIO by the end users as well as technical personnel, such as service technicians.

4E-GPIO is the 2nd version (2018) of the legacy 4E-GPIO (series 2017), which was released in limited edition. Legacy 4E-GPIO (series 2017) is discontinued.

REVISION AND APPROVAL

Rev.	Date	Nature of Changes	Approved By
02	16-10-2017	Added audio input & serial port pinout	DD
03	29-05-2018	New hardware revision and features	DD
04	29-06-2018	New graphics	AJH
05	10-07-2019	Minor corrections, typo's	DD
06	11-06-2020	Corrections	TvdH

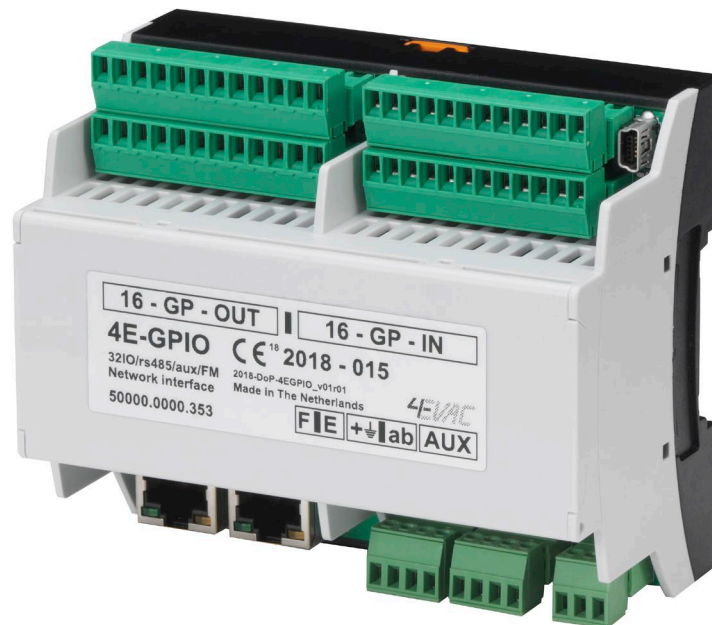

Hacousto Holland bv Industrieweg 87 2651BC Berkel & Rodenrijs		
4E-GPIO installation and user guide	Author:	DD

Table of Contents

1. What is the 4E-GPIO?	3
2. Where do I start?	3
3. Configuration settings	4
4. Hardware installation and settings	4
4.1. Inputs	4
4.2. GPO - General purpose outputs	5
4.3. EVAC / FAULT outputs	6
4.4. RS485, 24V DC out	6
4.5. LINE IN audio input	6
4.6. MIC input	7
4.7. Status LED	7
4.8. L-Net	8
4.8.1. Network ports	8
4.8.2. Redundant link	9
4.8.3. Network cabling	10
4.9. Device ID	11
5. Connections and recommended cable types	12
6. Technical specifications	13

Thank you for choosing 4EVAC as your Voice Evacuation System solution.

The 4EVAC Compact 500 is an all-in-one Voice Evacuation System box. The box contains a completely integrated Voice Evacuation System, capable of both standalone and network operation. The 4EVAC Compact 500 is certified in accordance with EN54-16 and EN54-4, which are harmonized standards under the Construction Products Regulation, mandatory in the European Union.

1. What is the 4E-GPIO?

4E-GPIO is a DIN-rail mounted I/O interface with input surveillance and a redundant network link, dedicated to the 4EVAC system network.

It features programmable 16 in / 16 out pins, mandatory EVAC and FAULT status output contacts, a monitored analog audio input and a monitored RS-485 interface for integration with third-party external control panels.

The 4E-GPIO can trigger any user defined event to any zone or set of zones in the entire system. It can also transmit an audio signal from the built-in local audio input to any zone over the system network.

The 4E-GPIO is connected to the L-Net interface of the Compact 500 main unit and may be daisy-chained with more L-Net devices. The 4E-GPIO may be used for emergency signals transmission, as well as for commercial purposes. As a component compliant with EN54-16, the 4E-GPIO features built-in surveillance of all input contacts, surveillance of serial ports, monitoring of audio inputs and network link surveillance. It also offers a redundant L-Net connection for backup of the critical transmission path.

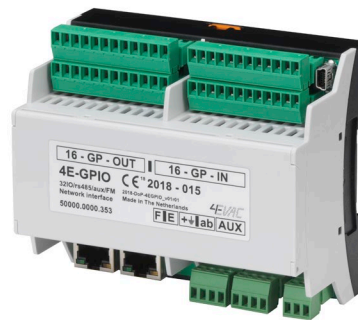

2. Where do I start?

First, make sure that you are officially allowed to access the hardware of Compact 500 system devices. This is usually the case if:

- you are an authorized representative of 4EVAC;
- you have been trained by 4EVAC or one of its authorized representatives for installation, service and commissioning of Compact 500 Voice Evacuation System.

Unauthorized hardware and/or software modifications are against the law and outside of the manufacturer's responsibility. If you have doubts about your status and access level permissions, please contact the 4EVAC main office.

Hacousto Holland bv Industrieweg 87 2651BC Berkel & Rodenrijs		
4E-GPIO installation and user guide	Author:	DD

i Important note: Access level 3 explanation

Opening the device housing or tampering with network cabling is restricted. This gives access to all interfaces, internal system connections and sensitive hardware settings that are of high importance to system operation mode, hardware reliability and safety (Access Level 3 according to EN54-16, Annex A). This access level (and higher) is strictly protected by the manufacturer and reserved only for service personnel which is trained, approved and officially certified by the manufacturer. Any actions carried out in Access Level 3 without the manufacturer's explicit approval may lead to incorrect settings or hardware damage, causing serious system malfunction, and therefore are strictly prohibited and void manufacturer's warranty.



3. Configuration settings

The settings for the 4E-GPIO are included in the configuration file located on the micro SD memory card installed in the Compact 500 main unit.

The configuration file includes user-defined settings, such as:

- Surveillance settings,
- Events triggered by every input,
- Audio input volume level,
- Device priority.

The configuration file should be prepared in the 4EVAC Manager. The 4EVAC Manager is GUI software running on Windows OS. All configuration settings are explained in the manual "4EVAC Manager guide".

i **NOTE:** Please make sure that the configuration file is prepared with the version of 4EVAC Manager compatible with the current firmware of your Compact 500 system.

The installation file of the latest 4EVAC Manager and the manual are available on our website: www.4EVAC.com

4. Hardware installation and settings

4.1. Inputs

There are 16 monitored inputs for receiving triggering signals for system events, e.g. evacuation message playback, background music activation, general purpose messaging, etc.

Each of these inputs has built-in DC monitoring which requires two resistors of 4.7kΩ + 10kΩ in series in order to detect an input active/inactive state as well as short and open faults. All inputs are sharing common ground potential [G].

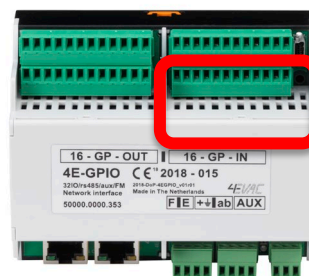

The EOL resistors must be located directly at the triggering output, preferably inside the external device (i.e. fire detection system) to provide reliable surveillance of the entire link.

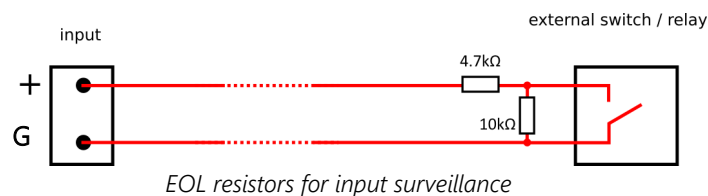
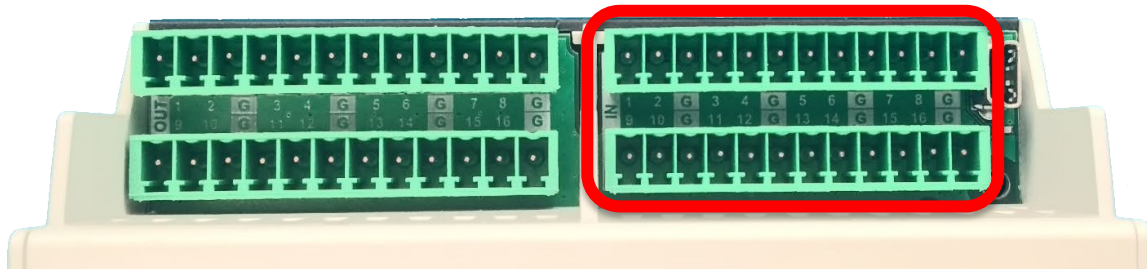

The contact inputs must receive an activation signal of at least 100ms in order to trigger events. Pulses shorter than 100ms will be ignored.

Monitoring of inputs may be deactivated in the configuration settings for each input separately. If an input is not monitored, creating an open or short circuit on this input will activate / deactivate this input.

4.2. GPO - General purpose outputs

There are 16 outputs to send triggering signals to external systems.

Each of these outputs may be linked to any event in the system.

GPOs are open collector outputs with a maximum rating of 40V / 150mA each.

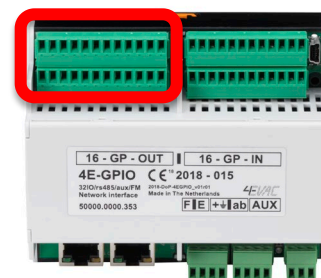

4.3. EVAC / FAULT outputs

Two opto-isolated outputs for reporting of the general status of the system:

- EVAC
This output is NORMALLY OPEN and closes when the system is in EVAC condition
- FAULT
This output is NORMALLY CLOSED and opens when the system is in the FAULT condition, or when the 4E-GPIO is unpowered.

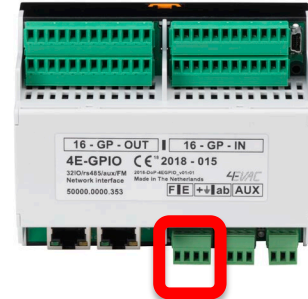

4.4. RS485, 24V DC out

4E-GPIO features a RS485 port to interface with external devices by means of serial link with built-in surveillance.

The serial interface is, by default, inactive. The data exchange protocol depends on the external system and can be selected in the configuration settings of the 4E-GPIO. For more explanation on the available serial protocols compatible with 4EVAC systems, see the 4EVAC Manager software manual.

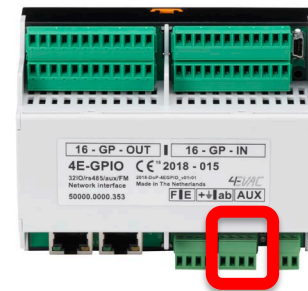

This four pin connector offers an additional 24V DC power output, delivering max. 200 mA to an external device, even when a mains failure occurs (guaranteed EN54-4 power supply).

4.5. LINE IN audio input

Analog balanced line level (0dBu) input with built in signal monitoring (signal presence).

This input may be linked to any event involving an external audio source, e.g. BGM or live EVAC from an external microphone panel.

Events using this audio input may be triggered via contact inputs or via a local RS485 serial bus by an external control panel.

Audio injected to this input is encoded on-the-fly and may be transmitted through the network to any zone in the system.

If input monitoring is enabled in the settings, the system expects to receive a constant audio signal through this input. If no signal is detected, the device will report a fault.

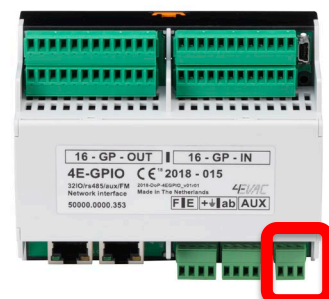

4.6. MIC input

This connector is dedicated to an optional 4E-FMP Firemen Panel Microphone; the same microphone as found on the front panel of the C500 main unit.



This input must be activated in the settings of the 4E-GPIO in order to enable emergency microphone functionality. When enabled, this interface provides mandatory monitoring of the entire microphone circuit, including the microphone element, PTT button and cable.

Once the PTT button of the attached microphone is pressed, the input will trigger the EVAC status and transmit a microphone signal to a pre-programmed group of zones with the highest signal priority.

Audio from the microphone is encoded on-the-fly and may be transmitted through the network to any zone in the system.

4.7. Status LED

The LED indicator shows general status of the device:

- Blue blink: booting
- Blue continuous: OK
- Yellow continuous: local device fault.
- Yellow blink: remote network device fault.



4.8. L-Net

4E-GPIO is a remote network device connected to the L-Net port of the C500 main unit. Multiple 4E-GPIO interfaces may be used in the same L-Net, with the following limitations:

- ❏ A maximum of 8 units per L-Net port
- ❏ A maximum of 16 units per single C500 main unit (total sum of all 3 L-net ports)

The GPIO interface may be also daisy-chained together with other L-Net devices.

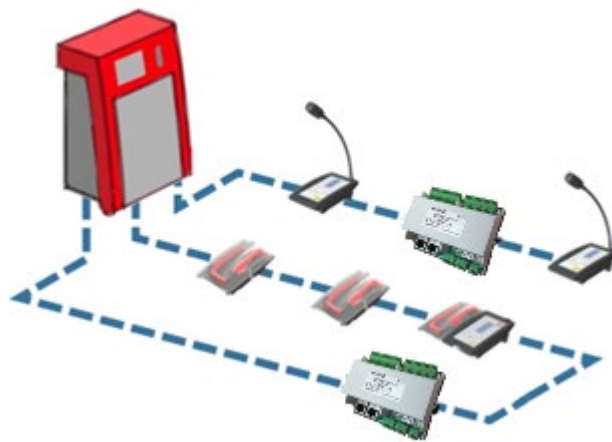

Compact 500 L-Net (local network)

4.8.1. Network ports

4E-GPIO offers 2 L-Net ports (RJ-45) for network connections to the C500 main unit and distributed parts of the 4EVAC Voice Evacuation System. Both L-Net ports are equal, therefore there is no difference which port is connected to which side of the L-Net daisy-chain.

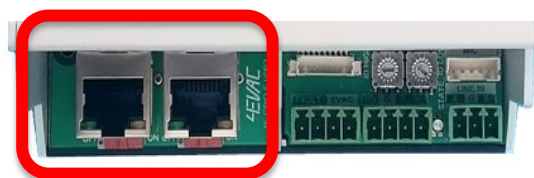

L-Net ports

4.8.2.Redundant link

If you need to make a redundant L-Net connection to the Compact 500 main unit, connect both L-Net ports of the device to two L-Net ports on the C500 main unit. You can choose any L-Net port on the C500 main unit. This creates a double daisy-chain of a redundant A/B power and data link to the device and ensures fail-safe networking in case of a single cable or port failure.

Both spurs of the redundant A/B link may be populated with other L-Net devices.



NOTE: The device is equipped with a power link jumper which, by default, is in the CLOSED position (pass-through power over L-Net). In order to create a redundant link, the jumper must be moved to the OPEN position. The device will be then immune to single port short-circuits of the power bus.



Location of power link jumpers

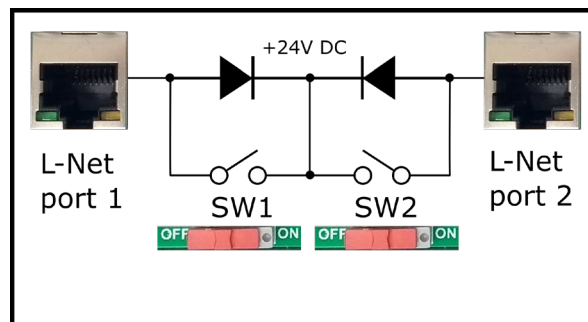

Power link jumpers.

When jumper 1 is closed (switch 1 on), the corresponding port 1 will pass through 24V DC from port 2 to the devices connected to port 1. Jumper 2 (switch 2) works accordingly, passing 24V DC received from port 1.

The power jumper should be used if the device is supposed to be connected via a redundant link. In this case the device must not pass through power towards the C500 on either of the 2 spurs of the redundant link.

4.8.3. Network cabling

The 4EVAC network features a full duplex RS-422 data link and 24V DC power to remote devices.

If you're building a distributed system using the 4EVAC network, you should make physical links between the devices using the right cables. The cabling should meet the following requirements:

1. Crossover twisted-pair cable (compatible with Ethernet crossover)

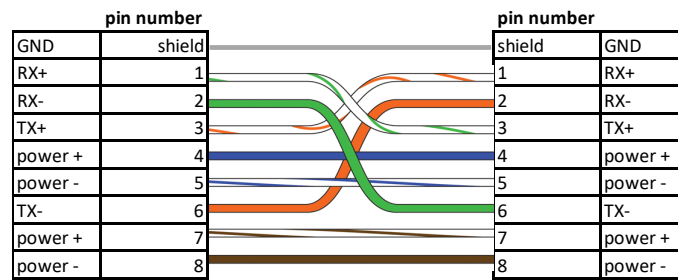
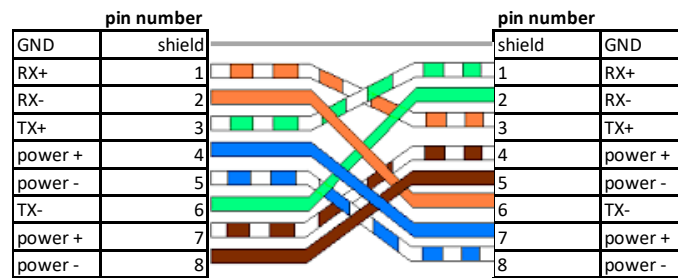

2. CAT5e or higher for maximum distance of 250m.
3. Non-CAT / lower than CAT5e: 250m not guaranteed.
4. Shield required (at least FTP)



NOTE: If you use a straight cable, the device will power up but the Tx/Rx data terminals will not be properly connected. This will result in a communication fault between the L-Net device and the C500 main unit. The L-Net device will not be able to initialize and thus will remain in its boot-sequence, not operational.



Caution! Use only crossover cables and keep the correct pinout! Connecting power pins to data pins will damage the network port.

Hacousto Holland bv Industrieweg 87 2651BC Berkel & Rodenrijs		
4E-GPIO installation and user guide	Author:	DD

4.9. Device ID

The GPIO unit needs an ID setting in order to be properly recognized in the network and operate.

If the device ID is duplicated or set to a wrong value, the device will not receive the correct configuration settings from the master Compact 500 main unit. In this case the network device will be stuck in its boot sequence and remain non-operational.

The device ID is set by means of two rotary switches, which define the two-digit hexadecimal value of the ID.



4E-GPIO: Device ID setting

5. Connections and recommended cable types

	How many	Connector type	Signal type	Additional information	Recommended cable (minimum)	Max. length
Inputs	16	pluggable screw terminal block 5.08 mm	Pull-down input with fault detection (open/short)	EOL resistors 10kΩ + 4.7kΩ in series for surveillance	Depends on length, typ. (N+1) x 0.5~1.5mm ² (N – number of individual triggering signals from / to external devices + one common pin)	1000 m
Outputs	16		Open collector output	max. 40V / 150mA		1000 m
EVAC / FAULT out	2		Potential-free opto-isolated output	EVAC out is NO FAULT out is NC	2 x 0.5 ~1.5 mm ²	1000 m
LINE IN audio	1		Analog balanced mono audio, 0dBu	signal presence monitoring (fault detection)	Balanced shielded microphone cable, typ. 2 x 0.25mm ²	100 m
RS485	1		RS485	Open protocol	2 x 0.5 mm ²	100 m
24 V out	1	24 V DC	max. 200 mA	2 x 0.5 mm ²	100 m	
MIC input	1	proprietary	PTT switch, power, audio	Dedicated for 4E-FMP fireman mic	n/a	n/a
L-Net port	3	RJ-45	Full duplex RS-422	Daisy chain with power delivery and redundant link	FTP CAT5e	250 m (from master C500)

Hacousto Holland bv Industrieweg 87 2651BC Berkel & Rodenrijs		
4E-GPIO installation and user guide	Author:	DD

6. Technical specifications

4E-GPIO	
Inputs	
logic inputs	16 programmable monitored logic inputs, 4.7kΩ +10kΩ EOL resistors
audio	1 x balanced analogue in, line-level mono, 22kΩ input impedance, monitored
mic	5 pin proprietary interface for 4E-FMP handheld fireman microphone
Outputs	
programmable	16 x open collector output (configurable NO/NC) max. 40V / 150mA each
system status out	2 x opto-isolated system status output EVAC (NO), FAULT (NC)
Serial port	RS-485, open protocol
Power consumption	
24V (L-Net)	max. 80mA
Audio performance	
Frequency response	100 Hz – 12 kHz
Digital audio format	24 kHz sampling, ADPCM compressed
Local network interface	
Architecture	Master-slave, up to 16 slave devices per C500 main unit
Connection	RJ-45, powered daisy chain, digital audio & control data, redundant
Cabling	X-over FTP CAT5e (or higher)
Current rating via single link	max. 500 mA (up to 8 slave devices) via L-Net port,
Max. length of L-Net link	250 m
Mechanical	
Dimensions HxWxD)	9 x 10.8 x 6.3 cm
Weight	124 g
Housing material	ABS
IP rating	IP 30
Mounting	DIN rail
Operating conditions	
Temperature	10–40°C
Relative humidity	max. 90% (non condensing)
Storage temperature	-40–70°C

All information provided in this document is subject to change without notice. 4EVAC may also make improvements and/or changes in the products described in this information at any time without notice.

Hacousto Holland bv Industrieweg 87 2651BC Berkel & Rodenrijs		
4E-GPIO installation and user guide	Author:	DD



4EVAC is a trade name of:

Hacousto Holland bv
 Industrieweg 87
 2651BC Berkel & Rodenrijs
 The Netherlands

www.4EVAC.com